

HL53KF

InFloor lefolyóttest - alacsony, DN40

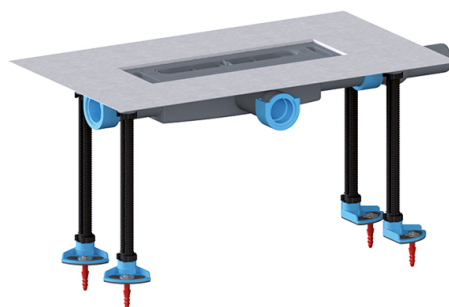

InFloor ultraalacsony lefolyóttest a síkban bárhol, de akár közvetlenül a fal melletti alkalmazásra, magasságállító lábakkal, kivehető szifonnal, DN40 gömbcsuklós lefolyócsonkkal, mely a test bal-, jobb-, vagy középső oldalára is szerelhető. A csomagban lévő szigetelő fólia a testre a betonozás után egyszerűen rögzíthető.



Műszaki rajz

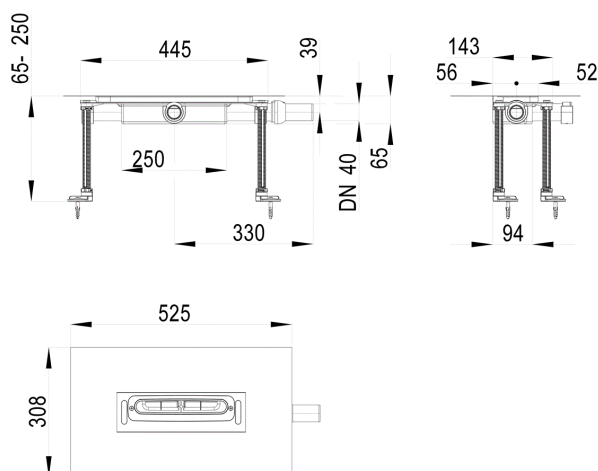

MŰSZAKI ADATOK

Anyag	PP	Beépítési magasság	65-250mm
Csatlakozó méret	DN40	Rácstartó	
Teljesítmény	0,4l/s	Lefolyórács	
Súly	1,25	Terhelési osztály	

FŐADATOK**Alkatrész****HL053.2E**

Szigetelő készlet szövetkasírozott fóliával

**HL053.4E**

Szifonbetét (lapos) a HL53KF-hez

**HL053N.1E**

Magasság állító készlet, 4 db.

Együtt használható**HL052M**

Rövidfolyóka látható rész 300x50mm nemesacélból, matta csiszolva a HL53K (InFloor) lefolyó testekhez

**HL052P**

Rövidfolyóka látható rész 300x50mm nemesacélból, fényes a HL53K (InFloor) lefolyó testekhez

**HL053M/100**

InFloor lefolyósín - matt nemesacél, 1000mm

**HL053M/110**

InFloor lefolyósín - matt nemesacél, 1100mm

**HL053M/120**

InFloor lefolyósín - matt nemesacél, 1200mm

**HL053M/130**

InFloor lefolyósín - matt nemesacél, 1300mm

**HL053M/140**

InFloor lefolyósín - matt nemesacél, 1400mm

**HL053M/150**

InFloor lefolyósín - matt nemesacél, 1500mm

**HL053M/80**

InFloor lefolyósín - matt nemesacél, 800mm

**HL053M/85**

InFloor lefolyósín - matt nemesacél, 850mm

**HL053M/90**

InFloor lefolyósín - matt nemesacél, 900mm

**HL053M/95**















InFloor lefolyósín - matt nemesacél, 950mm

**HL053P/100**

InFloor lefolyósín - fényes nemesacél, 1000mm

**HL053P/110**

InFloor lefolyósín - fényes nemesacél, 1100mm

-  **HL053P/120**
InFloor lefolyósín - fényes nemesacél, 1200mm
-  **HL053P/130**
InFloor lefolyósín - fényes nemesacél, 1300mm
-  **HL053P/140**
InFloor lefolyósín - fényes nemesacél, 1400mm
-  **HL053P/150**
InFloor lefolyósín - fényes nemesacél, 1500mm
-  **HL053P/80**
InFloor lefolyósín - fényes nemesacél, 800mm
-  **HL053P/85**
InFloor lefolyósín - fényes nemesacél, 850mm
-  **HL053P/90**
InFloor lefolyósín - fényes nemesacél, 900mm
-  **HL053P/95**
InFloor lefolyósín - fényes nemesacél, 950mm
-  **HL053S/100**
InFloor lefolyósín - "Standard" nemesacél, 1000mm
-  **HL053S/120**
InFloor lefolyósín - "Standard" nemesacél, 1200mm
-  **HL053S/90**
InFloor lefolyósín - "Standard" nemesacél, 900mm
-  **HL053WS/100**
InFloor lefolyósín - "Standard" nemesacél, 1000mm
-  **HL053WS/120**
InFloor lefolyósín - "Standard" nemesacél, 1200mm
-  **HL053WS/90**
InFloor lefolyósín - "Standard" nemesacél, 900mm
-  **HL6700**
Zajcsillapító elem a HL53KF-hez

CSOMAGOLÁSI ADATOK

Karton doboz

Csomagolás	1 [db]
Súly	1,55 [kg]
EAN/csomagolás	9003076041251
Magasság/Szélesség/Mély	100/200/575 [mm]
Térfogat	0,006402 [m ³]

Egyutas raklap

Csomagolás	56 [db]
Súly	96,8 [kg]
EAN/csomagolás	
Magasság/Szélesség/Mély	1000/800/1200 [mm]
Térfogat	1,728 [m ³]

LETÖLTÉSEK

Nyomtatás	HL53KF_pr.tif	max.
WEB	HL53KF_B.jpg	640x480/300dpi
Foto Parts List	HL53KF_gr.jpg	150x150/72dpi
Műszaki rajz	HL53KF_1_c.pdf	pdf
CAD	HL53KF_2_c1.dxf	dxf
Szerelési utasítás	HL53K(F)_Installation.pdf	
Brochure	HL53 InFloor Prospekt HU_26062017_web.pdf	
other	HL53_Cleaning.pdf	Cleaning / Reinigung