



COLLETTORI CON RUBINETTO MANIFOLDS WITH STOP COCKS

Serie MAXIMA

Descrizione / Description

Collettori lineari componibili con derivazioni dotate di rubinetto di chiusura. Disponibile con mandata da 3/4", 1" od 1 1/4" e 1, 2, 3, 4, 5 o 6 attacchi con interasse 36mm o 50mm.

Modular linear manifolds with ways provided of stop cocks. Available with delivery 3/4", 1" or 1 1/4" and 1, 2, 3, 4, 5 or 6 pipe connections with distance between axis of 36mm or 50mm..

I collettori di distribuzione "MAXIMA" sono generalmente utilizzati nelle reti di distribuzione di acqua calda e fredda. Grazie alla loro configurazione permettono l'alimentazione in parallelo delle utenze per acqua calda e/o fredda riducendo al minimo le perdite di carico. I collettori sono prodotti in conformità alle normative in materia e sono certificati relativamente alla composizione chimica dei materiali impiegati ed a livello dimensionale.

The distribution manifolds "MAXIMA" are typically used for hot and cold water distribution. Due to the configuration they may be used to distribute cold/hot water in parallel reducing at minimum the pressure drop. The manifolds are produced according to the relevant rules and are certified for material chemical composition and dimensional request.



Caratteristiche Tecniche

Temperatura max di esercizio : 110°C
 Temperatura min di esercizio : -20°C(*)
 Pressione max di esercizio : 16 bar
 Filettature : femmina ISO 228 (cilindrica)
 maschio ISO 228 (cilindrica)

Technical Features

Maximum temperature : 110°C
 Minimum temperature : -20°C(*)
 Maximum operating pressure : 16 bar
 Threads : female ISO 228 (parallel)
 male ISO 228 (parallel)

(*) purché il fluido rimanga in fase liquida / provided that the fluid remains in the liquid phase

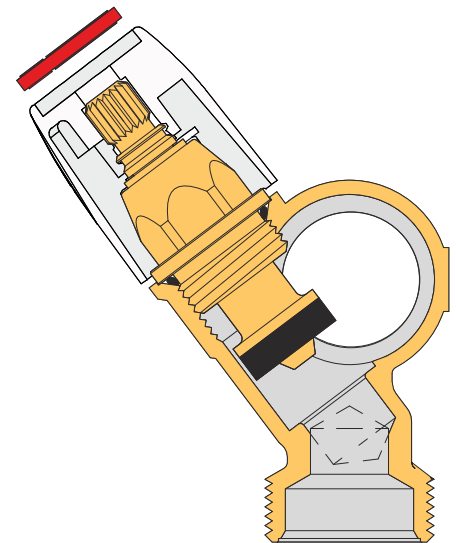

| Descrizione | Materiale | Trattamento | Description | Material | Treatment |
|------------------------|------------------------------|-------------|--------------------|-------------------------------|---------------|
| Corpo | Ottone CW617N - EN12165 | Cromato | Body | CW617N-EN12165 brass | Chrome plated |
| Vitone | Ottone CW617N - EN12164 | - | Head screw | CW617N-EN12164 brass | - |
| O-rings | Gomma etilene-propilene EPDM | - | O-rings | Etilene-propylene rubber EPDM | - |
| Guarnizione | Gomma etilene-propilene EPDM | - | Washer | Etilene-propylene rubber EPDM | - |
| Manopola | ABS bianca | - | Handle | ABS white | - |
| Dischetto segna utenza | ABS rosso/blu | - | Diskette marks use | ABS red/blue | - |

Certificazioni Certifications





Tabella dimensioni / Sizes table

| Size M/F | Vie/ Ways | A | B | C | D | E | E1 | F | G | H | I | L | Ø | Ch | Codice/ Code |
|----------|-----------|-------|-------|-----------|-----------|----|------|------|------|-------|-------|----|----|----|--------------|
| 3/4" | 1 | 3/4" | 36 | 1/2" | 16 | 13 | 15 | 27,5 | 24 | 51,5 | 39 | 44 | 28 | 32 | 1860163 |
| | 2 | 3/4" | 36 | 1/2" | 16 | 13 | 15 | 27,5 | 24 | 87,5 | 39 | 44 | 28 | 32 | 1860008 |
| | 3 | 3/4" | 36 | 1/2" | 16 | 13 | 15 | 27,5 | 24 | 123,5 | 39 | 44 | 28 | 32 | 1860005 |
| | 4 | 3/4" | 36 | 1/2" | 16 | 13 | 15 | 27,5 | 24 | 159,5 | 39 | 44 | 28 | 32 | 1860004 |
| | 5 | 3/4" | 36 | 1/2" | 16 | 13 | 15 | 27,5 | 24 | 195,5 | 39 | 44 | 28 | 32 | 1860010 |
| | 6 | 3/4" | 36 | 1/2" | 16 | 13 | 15 | 27,5 | 24 | 231,5 | 39 | 44 | 28 | 32 | 1860083 |
| 1" | 1 | 1" | 36 | 1/2" | 16 | 13 | 15,5 | 29 | 25,5 | 54,5 | 40 | 45 | 33 | 38 | 1860164 |
| | 2 | 1" | 36 | 1/2" | 16 | 13 | 15,5 | 29 | 25,5 | 90,5 | 40 | 45 | 33 | 38 | 1860022 |
| | 3 | 1" | 36 | 1/2" | 16 | 13 | 15,5 | 29 | 25,5 | 126,5 | 40 | 45 | 33 | 38 | 1860021 |
| | 4 | 1" | 36 | 1/2" | 16 | 13 | 15,5 | 29 | 25,5 | 162,5 | 40 | 45 | 33 | 38 | 1860020 |
| | 5 | 1" | 36 | 1/2" | 16 | 13 | 15,5 | 29 | 25,5 | 198,5 | 40 | 45 | 33 | 38 | 1860028 |
| | 6 | 1" | 36 | 1/2" | 16 | 13 | 15,5 | 29 | 25,5 | 234,5 | 40 | 45 | 33 | 38 | 1860084 |
| 3/4" | 2 | 3/4" | 36 | 24x19 fil | 18 | 12 | 15 | 27,5 | 24 | 87,5 | 37 | 44 | 28 | 32 | 1860023 |
| | 3 | 3/4" | 36 | 24x19 fil | 18 | 12 | 15 | 27,5 | 24 | 123,5 | 37 | 44 | 28 | 32 | 1860018 |
| | 4 | 3/4" | 36 | 24x19 fil | 18 | 12 | 15 | 27,5 | 24 | 159,5 | 37 | 44 | 28 | 32 | 1860014 |
| | 5 | 3/4" | 36 | 24x19 fil | 18 | 12 | 15 | 27,5 | 24 | 195,5 | 37 | 44 | 28 | 32 | 1860016 |
| | 6 | 3/4" | 36 | 24x19 fil | 18 | 12 | 15 | 27,5 | 24 | 231,5 | 37 | 44 | 28 | 32 | 1860085 |
| | 1" | 2 | 1" | 36 | 24x19 fil | 18 | 12 | 15,5 | 29 | 25,5 | 90,5 | 39 | 45 | 33 | 38 |
| 3 | | 1" | 36 | 24x19 fil | 18 | 12 | 15,5 | 29 | 25,5 | 126,5 | 39 | 45 | 33 | 38 | 1860003 |
| 4 | | 1" | 36 | 24x19 fil | 18 | 12 | 15,5 | 29 | 25,5 | 162,5 | 39 | 45 | 33 | 38 | 1860002 |
| 5 | | 1" | 36 | 24x19 fil | 18 | 12 | 15,5 | 29 | 25,5 | 198,5 | 39 | 45 | 33 | 38 | 1860001 |
| 6 | | 1" | 36 | 24x19 fil | 18 | 12 | 15,5 | 29 | 25,5 | 234,5 | 39 | 45 | 33 | 38 | 1860086 |
| 1"1/4 | | 2 | 1"1/4 | 36 | 24x19 fil | 18 | 13 | 17 | 31 | 32 | 99,0 | 45 | 50 | 44 | 48 |
| | 3 | 1"1/4 | 36 | 24x19 fil | 18 | 13 | 17 | 31 | 32 | 135,0 | 45 | 50 | 44 | 48 | 1860139 |
| | 4 | 1"1/4 | 36 | 24x19 fil | 18 | 13 | 17 | 31 | 32 | 171,0 | 45 | 50 | 44 | 48 | 1860140 |
| | 5 | 1"1/4 | 36 | 24x19 fil | 18 | 13 | 17 | 31 | 32 | 207,0 | 45 | 50 | 44 | 48 | 1860141 |
| | 6 | 1"1/4 | 36 | 24x19 fil | 18 | 13 | 17 | 31 | 32 | 243,0 | 45 | 50 | 44 | 48 | 1860142 |
| | 3/4" | 2 | 3/4" | 50 | 3/4" | 18 | 13 | 15 | 32 | 31 | 113,0 | 38 | 44 | 28 | 32 |
| 3 | | 3/4" | 50 | 3/4" | 18 | 13 | 15 | 32 | 31 | 163,0 | 38 | 44 | 28 | 32 | 1860011 |
| 4 | | 3/4" | 50 | 3/4" | 18 | 13 | 15 | 32 | 31 | 213,0 | 38 | 44 | 28 | 32 | 1860015 |
| 1" | 2 | 1" | 50 | 3/4" | 18 | 13 | 15,5 | 32 | 31 | 113,0 | 39,5 | 45 | 33 | 38 | 1860024 |
| | 3 | 1" | 50 | 3/4" | 18 | 13 | 15,5 | 32 | 31 | 163,0 | 39,5 | 45 | 33 | 38 | 1860013 |
| | 4 | 1" | 50 | 3/4" | 18 | 13 | 15,5 | 32 | 31 | 213,0 | 39,5 | 45 | 33 | 38 | 1860019 |
| 3/4" | 2 | 3/4" | 50 | 24x19 fil | 18 | 13 | 15 | 32 | 31 | 113,0 | 37 | 44 | 28 | 32 | 1860043 |
| | 3 | 3/4" | 50 | 24x19 fil | 18 | 13 | 15 | 32 | 31 | 163,0 | 37 | 44 | 28 | 32 | 1860041 |
| | 4 | 3/4" | 50 | 24x19 fil | 18 | 13 | 15 | 32 | 31 | 213,0 | 37 | 44 | 28 | 32 | 1860044 |
| 1" | 2 | 1" | 50 | 24x19 fil | 18 | 13 | 15,5 | 32 | 31 | 113,0 | 39 | 45 | 33 | 38 | 1860032 |
| | 3 | 1" | 50 | 24x19 fil | 18 | 13 | 15,5 | 32 | 31 | 163,0 | 39 | 45 | 33 | 38 | 1860031 |
| | 4 | 1" | 50 | 24x19 fil | 18 | 13 | 15,5 | 32 | 31 | 213,0 | 39 | 45 | 33 | 38 | 1860029 |



Diagramma portata/perdita di carico - Flow/pressure drop diagram

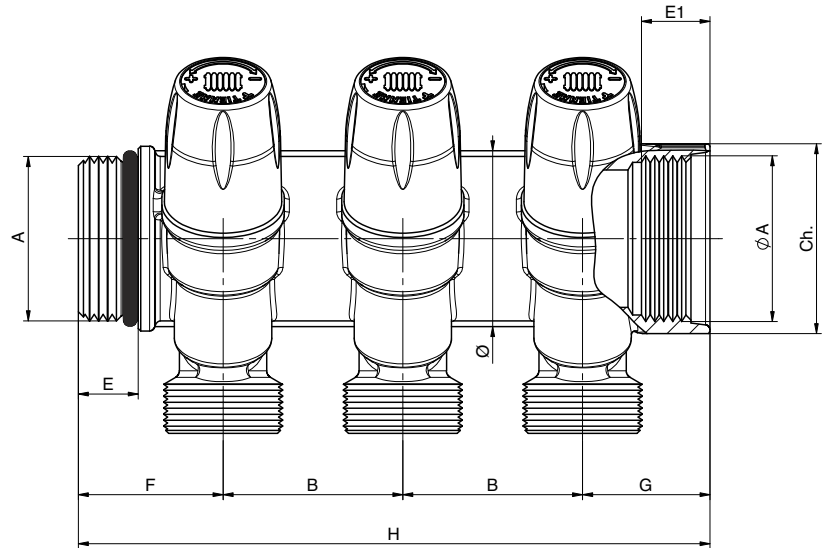
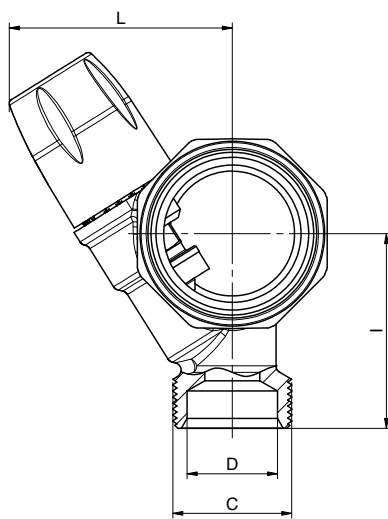
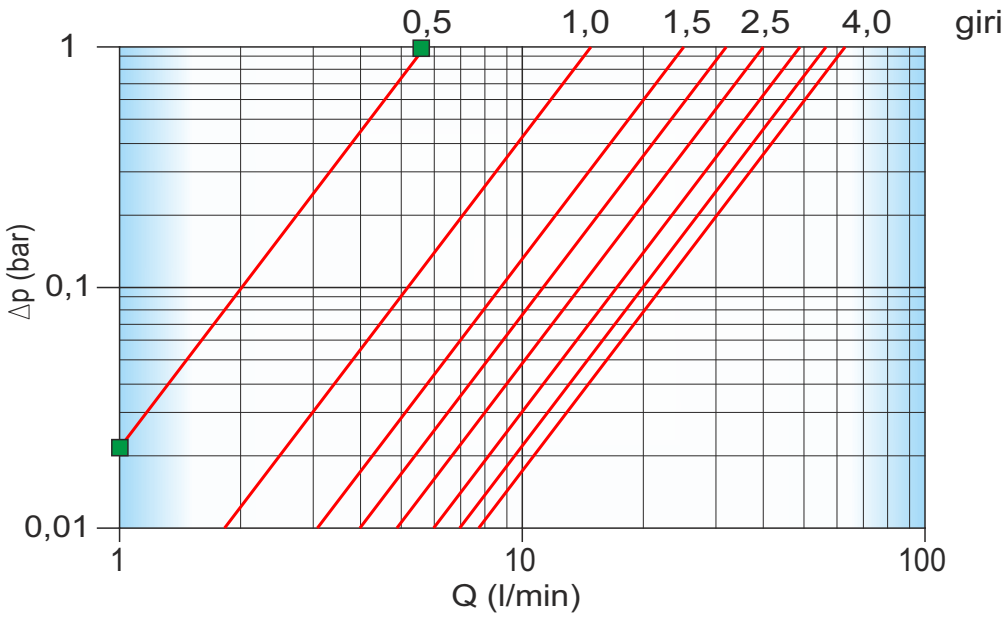

| | | | |
|----|------------------|----|------|
| —■ | 0,5 giri / turns | Kv | 0,34 |
| — | 1,0 giri / turns | Kv | 0,91 |
| — | 1,5 giri / turns | Kv | 1,44 |
| — | 2,0 giri / turns | Kv | 1,91 |
| — | 2,5 giri / turns | Kv | 2,40 |
| — | 3,0 giri / turns | Kv | 2,89 |
| — | 3,5 giri / turns | Kv | 3,33 |
| — | 4,0 giri / turns | Kv | 3,78 |

Collettore interasse 36mm con derivazioni 1/2"x16 (1866K-1868K)
 Manifold with 1/2"x16 outlets and distance between axis of 36mm (1866K-1868K)

Guida alle connessioni
 Fitting guide

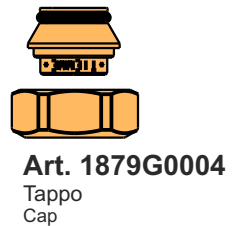
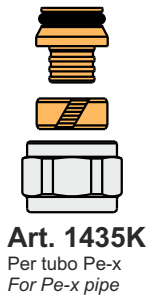
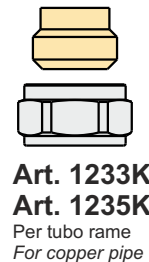
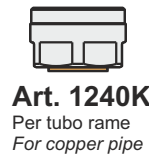
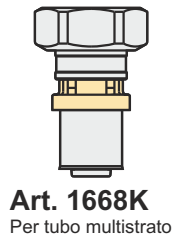
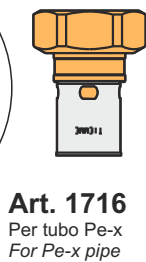
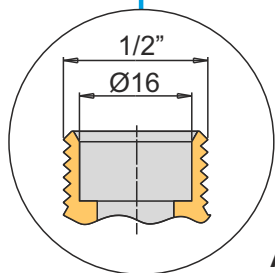
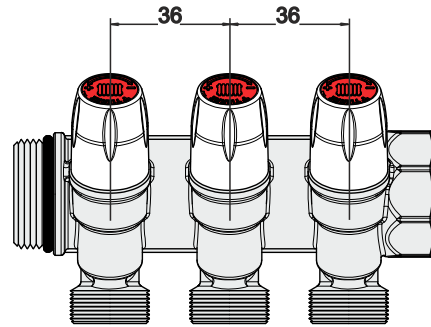
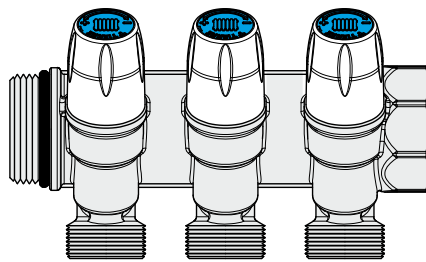
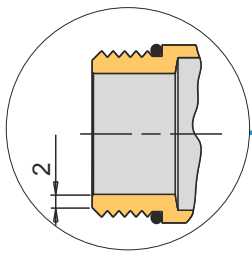
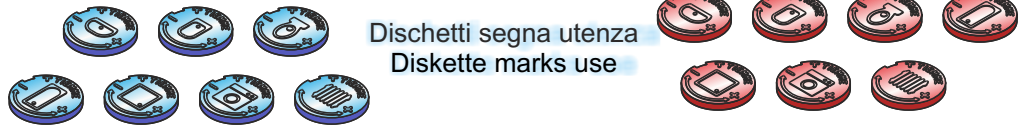



Collettore interasse 36mm con derivazioni 24x19fil-18 (1877K36)
Manifold with 24x19fil-18 outlets and distance between axis of 36mm (1877K36)

Guida alle connessioni / Fitting guide

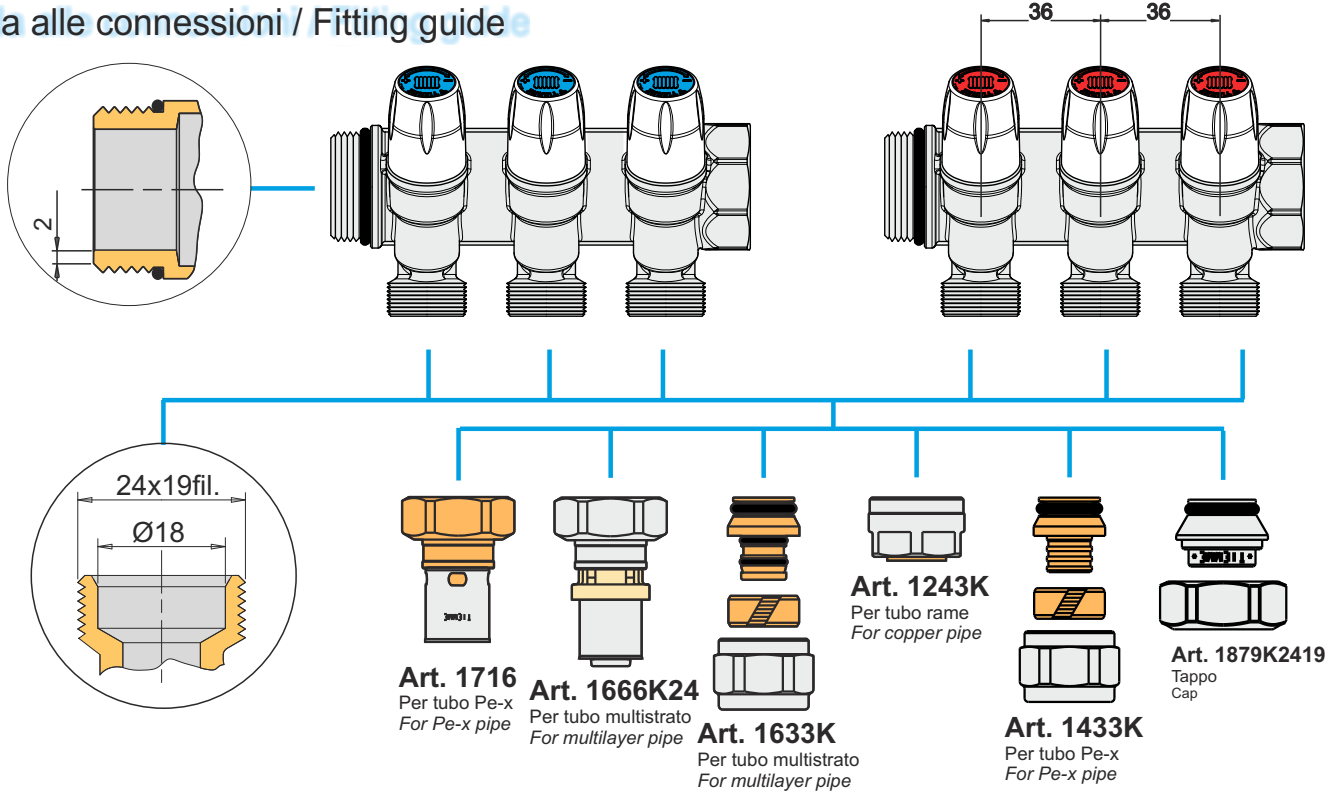

Collettore interasse 50mm con derivazioni 3/4"x18 Eurocono (1877K5005)
Manifold with 3/4"x18 Euroconus outlets and distance between axis of 50mm (1877K5005)

Guida alle connessioni / Fitting guide

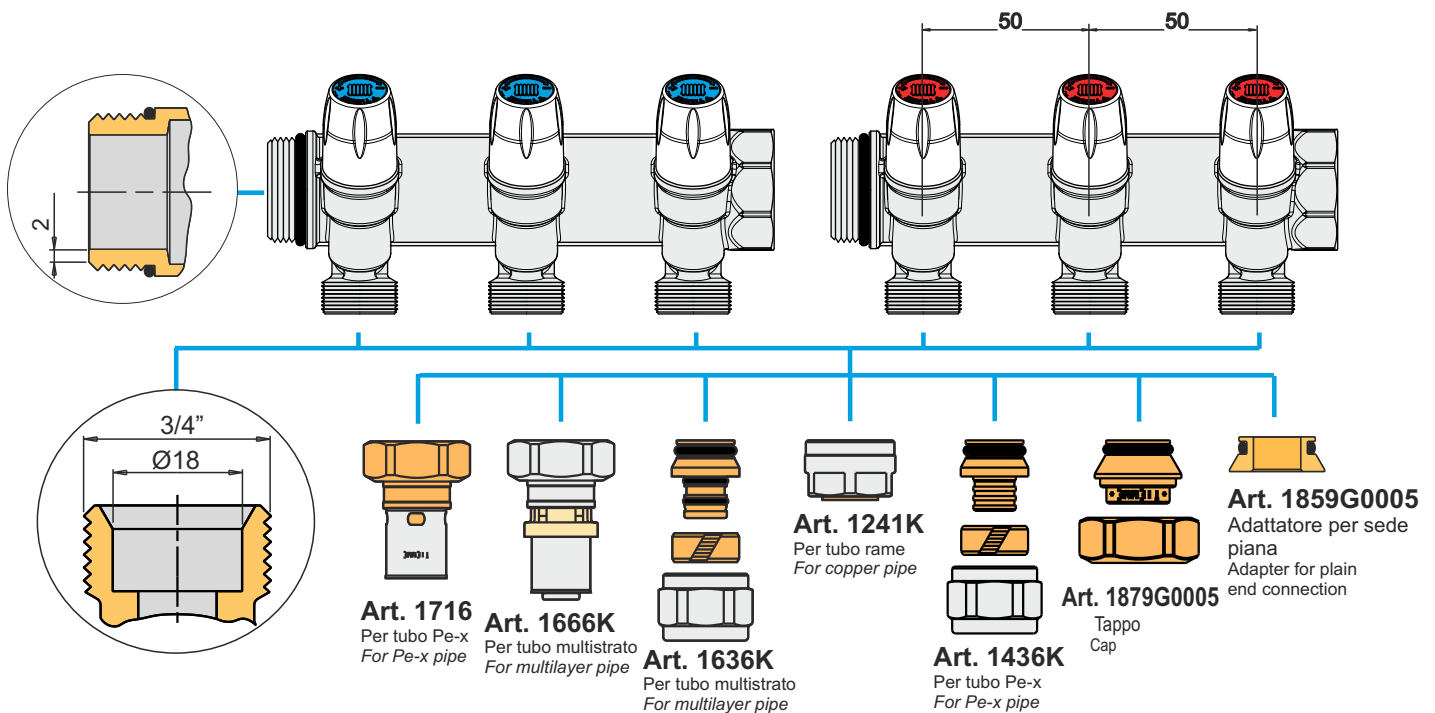



Collettore interasse 50mm con derivazioni 24x19fil-18 (1877K5019)
Manifold with 24x19fil-18 outlets and distance between axis of 50mm (1877K5019)

Guida alle connessioni / Fitting guide

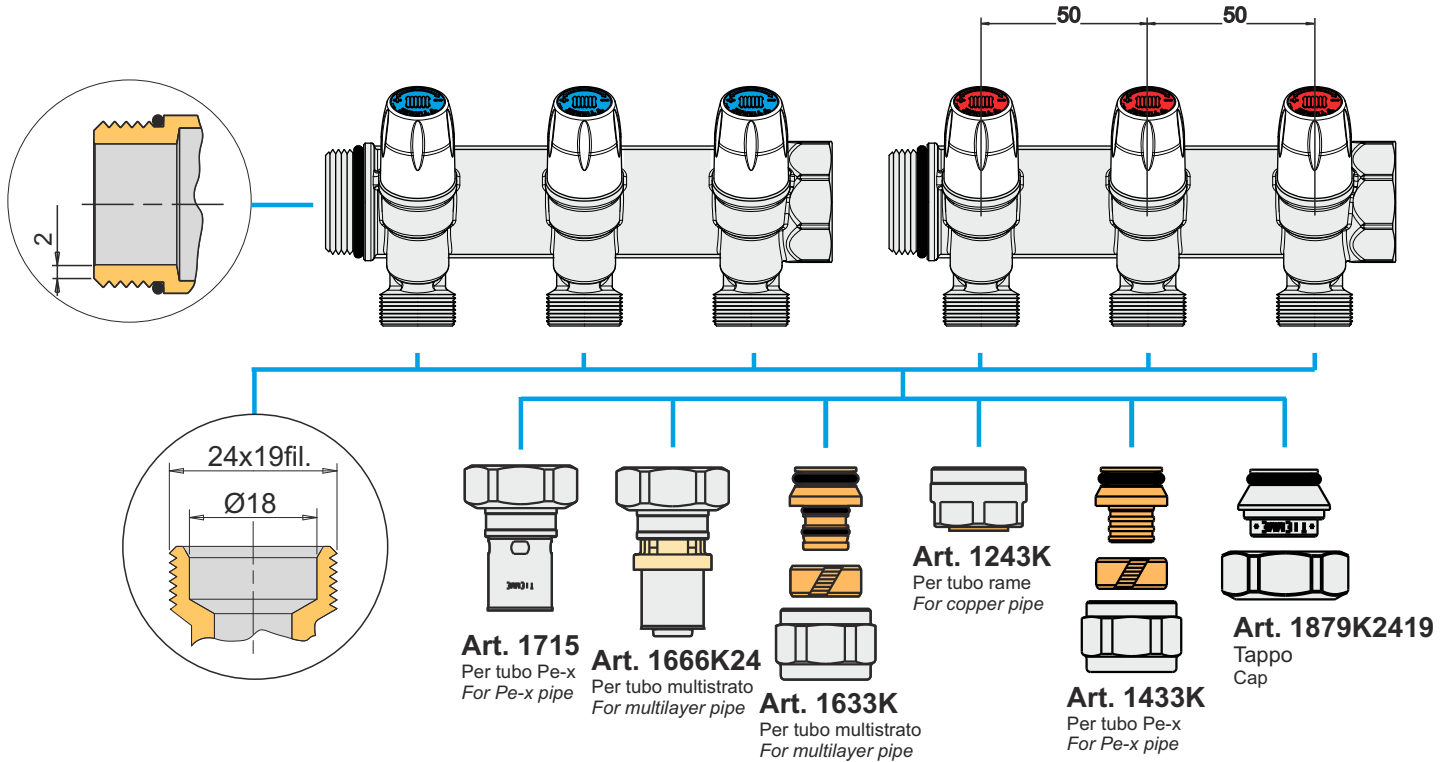

Esempio di accoppiamento collettori con filettatura maschio/femmina fasata
Example of connection for manifolds with male/female self-seal thread

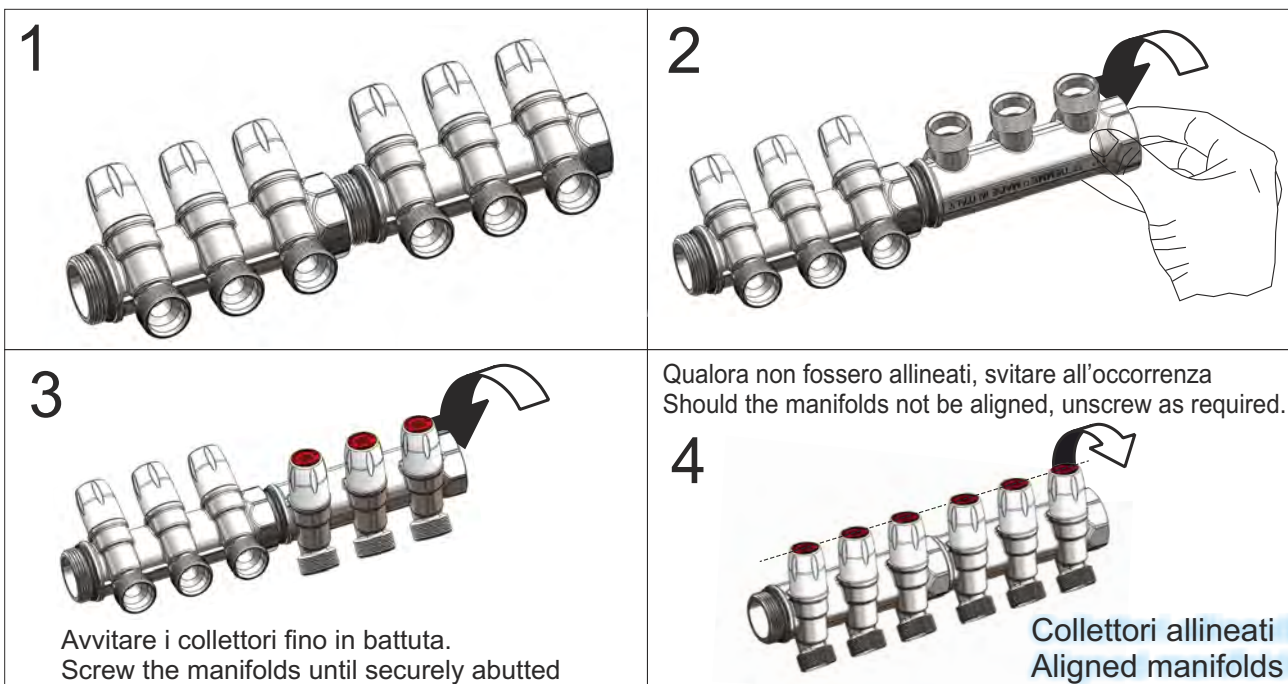



Cassette utilizzabili
Boxes used

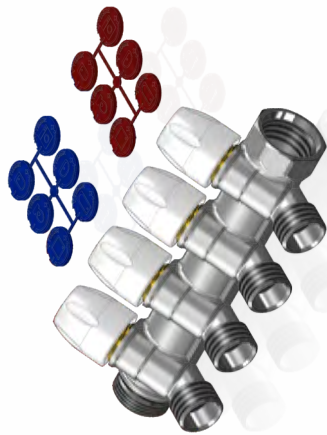
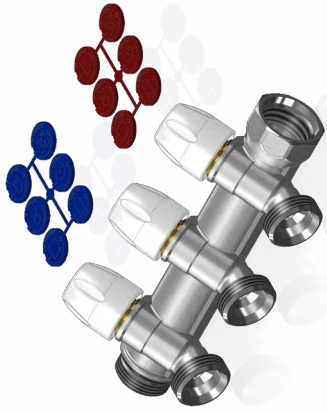

ART. 1939/1940

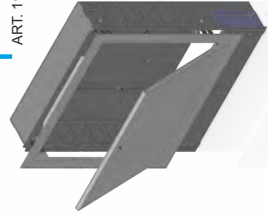

Cassetta regolabile
in altezza e
profondità
Metallic box with
height and
depth adjustable



ART. 1870



Supporto per collettori
Holding set for manifolds



ART. 1939/1940

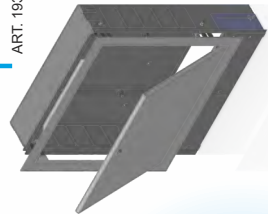

Cassetta regolabile in
altezza e profondità
Metallic box with height and
depth adjustable



ART. 1877SKIT



Kit di fissaggio
per collettori
Manifolds bracket



ART. 1920-1930

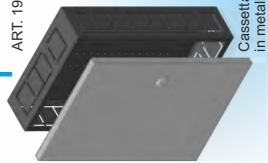

Cassetta universale
in metallo
Universal metallic box



ART. 1807

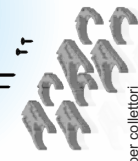

Supporti per collettori
Holding set for manifolds



ART. 1810



Cassetta universale
Universal box



ART. 1807

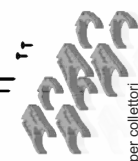

Supporti per collettori
Holding set for manifolds



ART. 1812

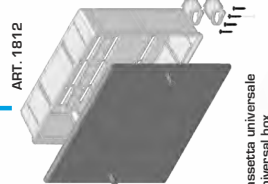

Cassetta universale
Universal box



ART. 1807



Supporti per collettori
Holding set for manifolds



TIEMME Raccorderie S.p.A.
Via Cavallera 6/A (Loc. Barco) - 25045 Castegnato (Bs) - Italy
Tel +39 030 2142211 R.A. - Fax +39 030 2142206
info@tiemme.com - www.tiemme.com